



RF Admittance Level Transmitter



PRODUCT INTRODUCTION

PRINCIPLE

RF Admittance Level Transmitter utilizes the capacitance formed between the sensing probe and the reference probe or the metal vessel wall to calculate the level of the medium inside the vessel according to the capacitance theory that the capacitance and vessel are proportional increased.

When the probe is surrounding by the air, little capacitance (C_A) is measured by the equivalent capacitor, the capacitance increase gradually as computing media, the max. capacitance (C_B) will be measured while the tank is full, the difference (dC) between C_A and C_B is proportional to the level. (Recommend range $dC = 25 \sim 2000 \text{ pF}$)

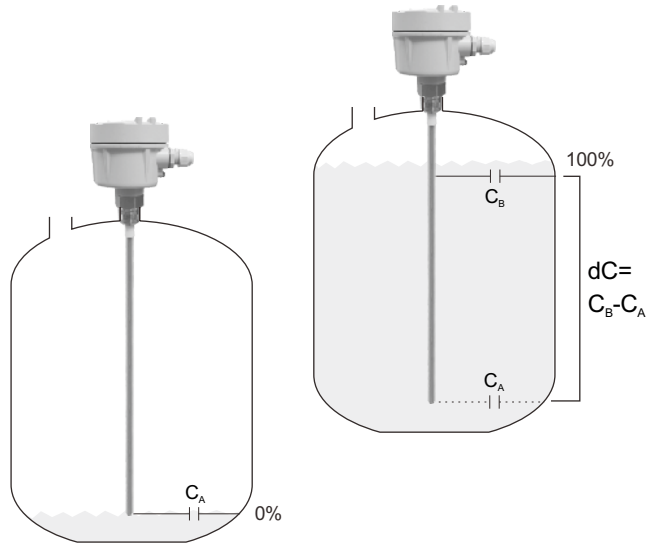

FEATURES

- 4~20mA 2 wire Loop power
- Low consumption of power (20mA Max)
- High accuracy of linearity ($\pm 1\% \text{ FS}$ or $\pm 0.5\text{pF}$)
- Temperature compensation, low temperature effect ($\pm 0.2\% \text{ FS}/^\circ\text{C}$ or $0.1\text{pF}/^\circ\text{C}$)
- Easy calibration (Any 2 points for calibration)
- No blind distance, ideal for different tanks
- Suitable for high temperature, high pressure and corrosive environment
- LCD local display

APPLICATION EXAMPLE

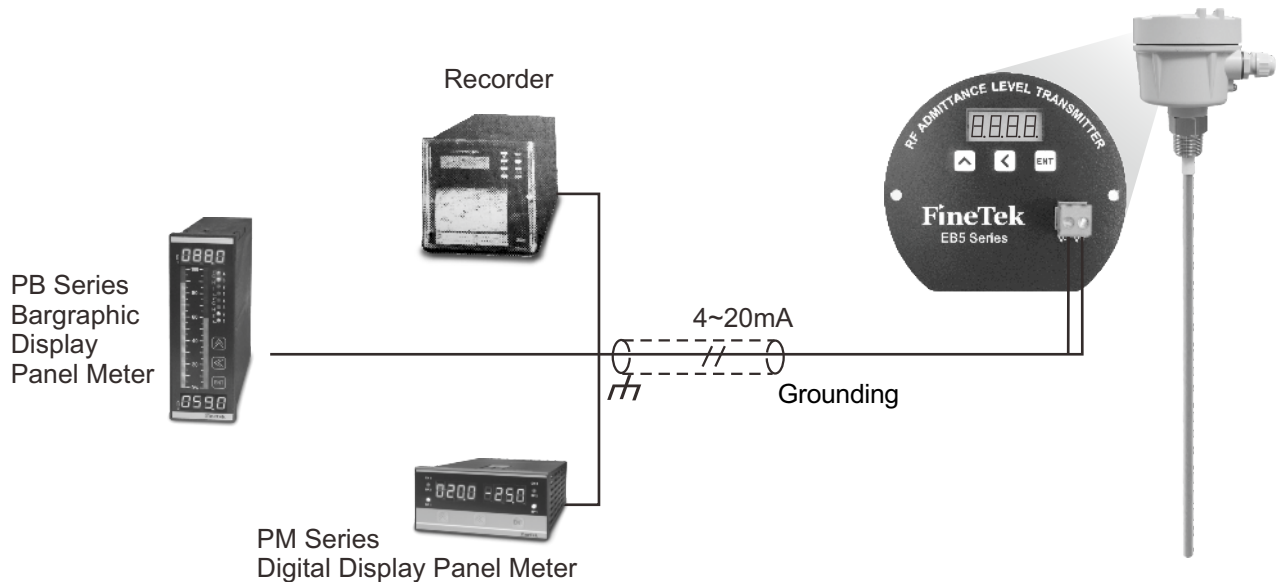

APPLICATION EXAMPLE

	EB5200	EB5201	EB52A0	EB52A1	EB5300	EB5301	EB53A0	EB53A1	EB5400	EB54A0
Conductive Tank	★	★	★	★	★	★	★	★	✗	✗
Non-Conductive Tank	▲	▲	▲	▲	✗	✗	✗	✗	★	★
Height of Vessel > 4m	✗	✗	✗	✗	★	★	★	★	✗	✗
Height of Vessel < 4m	★	★	★	★	—	—	—	—	★	★
Operation Temperature > 80°C (Not more than 200°C)	✗	★	✗	★	✗	★	✗	★	✗	✗
Dielectric Constant of Media>4	✗	✗	★	★	✗	✗	★	★	✗	★
Dielectric Constant of Media<4	★	★	—	—	★	★	—	—	★	—
Agitator inside the vessel	▲	▲	▲	▲	✗	✗	✗	✗	—	—

★ Good ▲ Pipe shield is suggested ✗ Unsuitable — Fair

	EB5200	EB5201	EB52A0	EB52A1	EB5300	EB5301	EB53A0	EB53A1	EB5400	EB54A0
Aqueous Solution	✗	✗	★	★	✗	✗	★	★	✗	★
Oil Solution	▲	▲	✗	✗	✗	✗	✗	✗	✗	✗
Acid or Alkali Solution	✗	✗	★	★	✗	✗	★	★	✗	★
Feed & Grain	★	★	✗	✗	★	★	✗	✗	✗	✗
Mining & Cement	★	★	✗	✗	★	★	✗	✗	✗	✗

★ Good ▲ Pipe shield is suggested ✗ Unsuitable

DIELECTRIC CONSTANTS CHART

Material	Dielectric Constant	Material	Dielectric Constant	Material	Dielectric Constant	Material	Dielectric Constant
Air	1	Heavy Oil	2.6~3.0	Cement	4~6	Acetone	20~30
Gasoline	1.9	Grain	2.5~4.5	Butanol	11	Carbide Powder	25~30
Diesel	2.1	Corn	2.3~2.6	Ethanol	16~31	Sulfuric Acid	84
Edible Oil	2~4	Rice	3~8	Ammonia	21	Water	81

WIRING AND CAUTION

- After installation of the Admittance Level Transmitter on the top of tank, please make sure the cover of the transmitter is contacted with tank perfectly. Please avoid the grounding of panel meter to touch the tank wall.
- While the panel meter is not supplied with a power supply, please prepare a 24V power supply for use.
- The max cable length is depends on the max resistance .Maximum resistance is not to exceed $(V_s-22) \times 50\Omega$ to ensure the accuracy of measurement.
- Make sure to separate the signal cable with other big power cables (such as pump, conveyor and solenoid valve)while wiring. Before turning on power, make sure all wirings are correct.
- Connect isolation cable with GND of power.
- If there is heater or other electric device in the application, contacting the cover of the transmitter and tank can decrease EMI.

STANDARD TYPE

Dimensions (unit:mm)	<p>Suitable for middle/ small tank Media : non-conductive material low moisture material</p>	<p>Suitable for middle/big tank Media: Dielectric Constant >4 Conductive Material</p>	<p>Suitable for middle/ small tank Media : non-conductive material low moisture material</p>	<p>Suitable for middle/big tank Media: Dielectric Constant >4 Conductive Material</p>	
	Model No.	EB5200 Rod Probe	EB52A0 Rod Coating Type	EB5201 Hi-Temp Rod Probe	EB52A1 Hi-Temp Rod Coating
	Probe material	SUS304	SUS304 with PFA Coating	SUS304	SUS304 with PFA Coating
	Ambient temperature	-40~85°C LCD monitor: -20~85°C			
Operating temperature	-40~85°C		-40~200°C		
Operation voltage	18~30Vdc				
Analog output	4~20mA(two wire)				
Digital output	HART(option)				
Measuring range	20~2000pF				
Accuracy	± 1% FS or ± 0.5pF				
Effect temp.	< ± 0.2% FS/°C or 0.1pF/°C				
Protection	IP65				
Connection	1"PT or 1"x5kg/cm² flange				
Weight	Approx. 2.3kg(1m)	Approx. 2.3kg(1m)	Approx. 2.8kg(1m)		
Operating pressure	40kg/cm²	32kg/cm²	40kg/cm²	32kg/cm²	

STANDARD TYPE

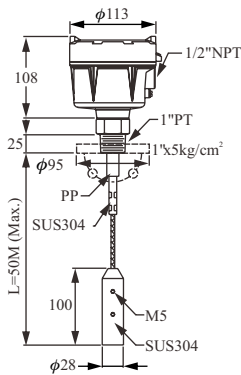
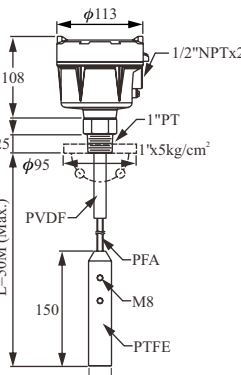
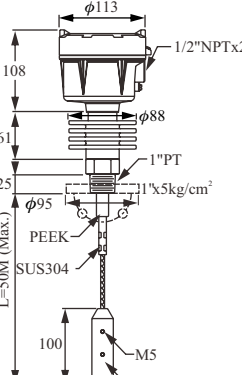
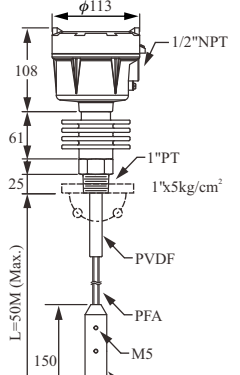
Dimensions (unit:mm)	 <p>Suitable for middle/ small tank Media : non-conductive material low moisture material</p>	 <p>Suitable for middle/big tank Media: Dielectric Constant >4 Conductive Material</p>	 <p>Suitable for middle/ small tank Media : non-conductive material low moisture material</p>	 <p>Suitable for middle/big tank Media: Dielectric Constant >4 Conductive Material</p>
Model No.	EB5300 Cable Type	EB53A0 Cable Coating Type	EB5301 Hi-Temp Cable Type	EB53A1 Hi-Temp Cable Coating
Probe material	SUS304	SUS304 with PFA Coating	SUS304	SUS304 with PFA Coating
Weight material	SUS304	PTFE	SUS304	PTFE
Ambient temperature	-40~85°C LCD monitor: -20~85°C			
Operating temperature	-40~85°C		-40~200°C	
Tensile strength	2000Kgf			
Operation voltage	18~30Vdc			
Analog output	4 ~20mA(two wire)			
Digital output	HART(option)			
Measuring range	20~2000pF			
Accuracy	± 1% FS or ± 0.5pF			
Effect temp.	< ± 0.2% FS/°C or 0.1pF/°C			
Protection	IP65			
Connection	1"PT or 1"x5kg/cm ² flange			
Weight	Approx. 2.3kg(1m)	Approx. 2.3kg(1m)	Approx. 2.8kg(1m)	
Operating pressure	40kg/cm ²	32kg/cm ²	40kg/cm ²	32kg/cm ²

STANDARD TYPE

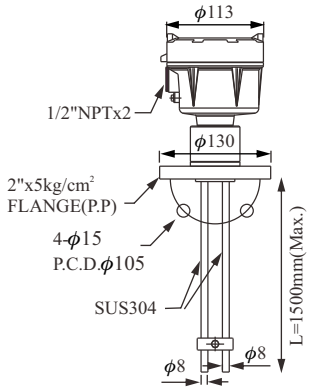
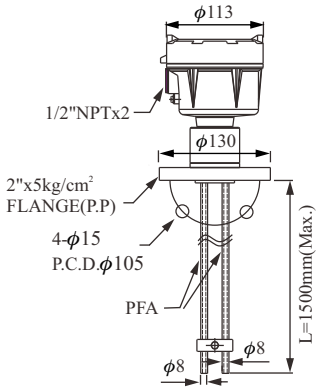
<p>Dimensions (unit:mm)</p>	 <p>Suitable for middle/ small non-conductive tank Media : non-conductive material low moisture material</p>	 <p>Suitable for middle/ small non-conductive tank Media: Conductive Material</p>
<p>Model No.</p>	<p>EB5400 Two Rode Probe</p>	<p>EB54A0 Two Coating Rode Probe</p>
<p>Probe material</p>	<p>SUS304</p>	<p>SUS304 with PP / PFA Coating</p>
<p>Ambient temperature</p>	<p>-40~85°C</p>	<p>-40~85°C</p>
	<p>LCD monitor: -20~85°C</p>	<p>LCD monitor: -20~85°C</p>
<p>Operating temperature</p>	<p>-40~85°C</p>	<p>-40~85°C</p>
<p>Operation voltage</p>	<p>18~30Vdc</p>	<p>18~30Vdc</p>
<p>Analog Output</p>	<p>4 ~20mA(two wire)</p>	<p>4 ~20mA(two wire)</p>
<p>Digital output</p>	<p>HART(option)</p>	<p>HART(option)</p>
<p>Measuring range</p>	<p>20~2000pF</p>	<p>20~2000pF</p>
<p>Accuracy</p>	<p>± 1% FS or ± 0.5pF</p>	<p>± 1% FS or ± 0.5pF</p>
<p>Effect temp.</p>	<p>< ± 0.2% FS/°C or 0.1pF/°C</p>	<p>< ± 0.2% FS/°C or 0.1pF/°C</p>
<p>Protection</p>	<p>IP65</p>	<p>IP65</p>
<p>Connection</p>	<p>2"x5kg/cm² flange</p>	<p>2"x5kg/cm² flange</p>
<p>Weight</p>	<p>Approx. 2.3kg(1m)</p>	<p>Approx. 2.3kg(1m)</p>
<p>Operating pressure</p>	<p>5kg/cm²</p>	<p>5kg/cm²</p>

Note:Min. Connection is 2" flange

STANDARD TYPE

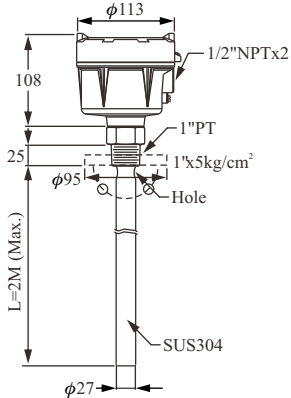
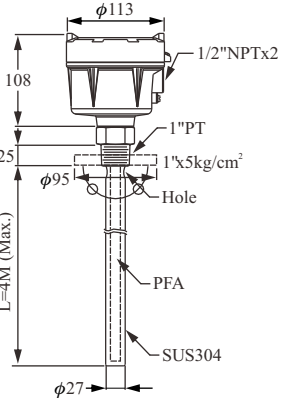
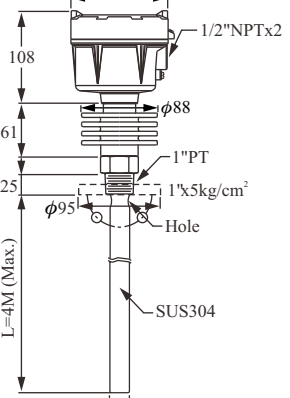
<p>Dimensions (unit:mm)</p>	 <p>Suitable for middle/ small tank Media : non-conductive material low moisture material</p>	 <p>Suitable for middle/big tank Media: Dielectric Constant >4 Conductive Material</p>	 <p>Suitable for middle/ small tank Media : non-conductive material low moisture material</p>
Model No.	EB5500 Anti-wave tube Type	EB55A0 Anti-wave tube Type	EB5501 Hi-Temp Anti-wave tube Type
Probe material	SUS304	SUS304 with PFA Coating	SUS304
Ambient temperature	-40~85°C	-40~85°C	-40~85°C
	LCD monitor: -20~85°C	LCD monitor: -20~85°C	LCD monitor: -20~85°C
Operating temperature	-40~85°C	-40~85°C	-40~200°C
Operation voltage	18~30Vdc	18~30Vdc	18~30Vdc
Analog output	4~20mA(two wire)	4~20mA(two wire)	4~20mA(two wire)
Digital output	HART(option)	HART(option)	HART(option)
Measuring range	20~2000pF	20~2000pF	20~2000pF
Accuracy	± 1% FS or ± 0.5pF	± 1% FS or ± 0.5pF	± 1% FS or ± 0.5pF
Effect temp.	< ± 0.2% FS/°C or 0.1pF/°C	< ± 0.2% FS/°C or 0.1pF/°C	< ± 0.2% FS/°C or 0.1pF/°C
Protection	IP65	IP65	IP65
Connection	1"PT or 1"x5kg/cm² flange	1"PT or 1"x5kg/cm² flange	1"PT or 1"x5kg/cm² flange
Weight	Approx. 2.3kg(1m)	Approx. 2.3kg(1m)	Approx. 2.8kg(1m)
Operating pressure	40kg/cm²	32kg/cm²	40kg/cm²

Note :Hi-Temp Wire Coating Type is available, the model is EB55A1 with PFA Coating

CALIBRATION & SETUP

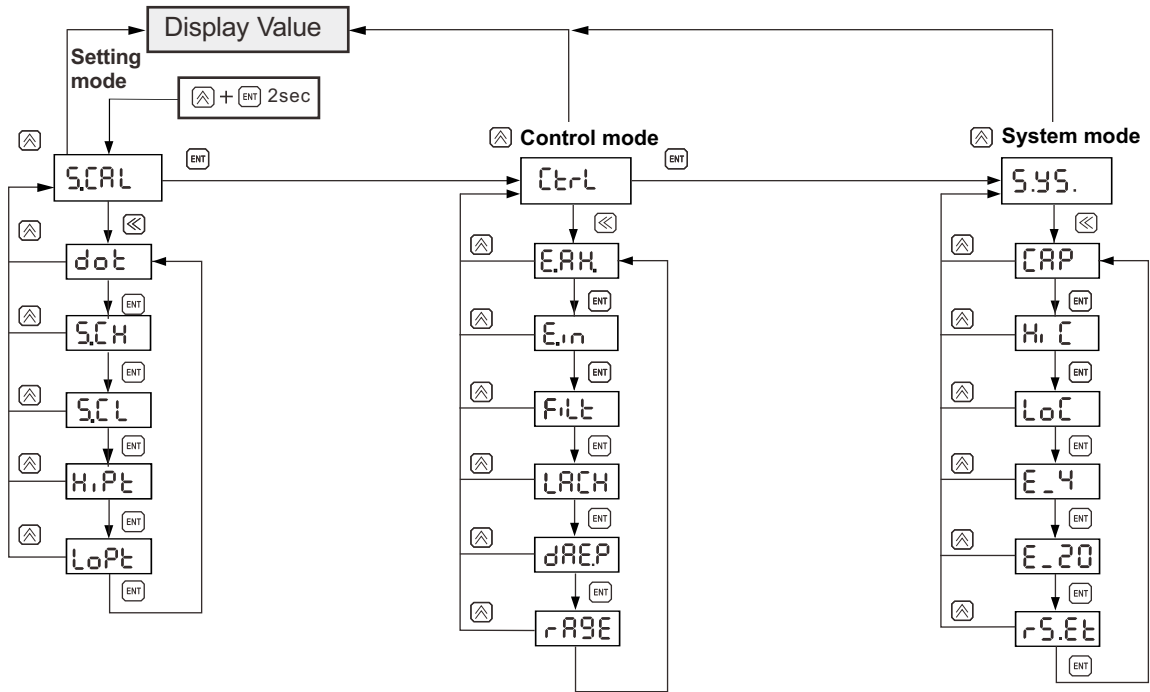

A: A B: b C: C D: d E: E F: F G: 9 H: H I: I J: J
 K: k L: L M: E N: n O: o P: P Q: 9 R: r S: S T: t
 U: u V: u W: 3 X: H Y: y Z: 2

Main Menu	Sub-Menu	Range	Default	Description
S.CAL	dot	0~3	1	Decimal point setting
	S.CH	-1999~9999	100.0	20mA corresponding display value
	S.CL	-1999~9999	0	4mA corresponding display value
	H.Pt	-1999~9999	100.0	Value for high point (Hipt).
	LoPt	-1999~9999	0	Value for low point (Lopt).
Ctrl	E.AH	SAVE,RSET BACK	SAVE	Memory for max & mini value during operation. SAVE: Save value into Eeprom REST: Clean present value and memory BACK: Go back to sub-menu
	E.in	SAVE,RSET BACK	SAVE	
	Filt	Lo,MID,HI	LO	Software Filter
	LACH	ON, OFF	OFF	Output latch
	dREP	1~60sec	1	Reflash time
	r.AGE	HI,Lo	HI	Measuring range
S.YS.	CAP	0~9999		Capacity Value
	HiC	0~9999	2200	High point Capacity Value
	LoC	0~9999	200	Low point Capacity Value
	E_4	-1999~9999	0	4mA fine turn
	E_20	-1999~9999	0	20mA fine turn
	r.S.Et			Load default

Note 1: The setting of Hipt, LoPt please refer to calibration procedures on the manual

Note 2: The output will latch when display is 110% or -10%

Note 3: Re-Calibration is necessary if measuring range is changed

EXPLOSION PROOF TYPE

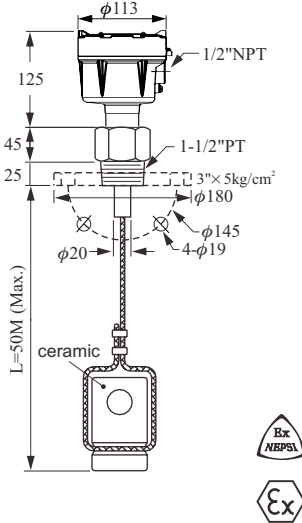
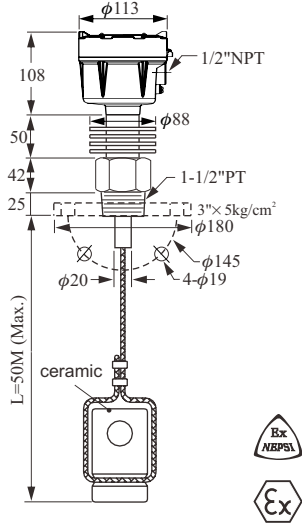
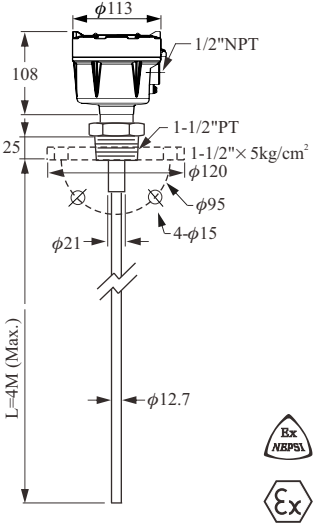
Dimensions (unit:mm)	 <p>Suitable for non-conductive material and big tank.</p>	 <p>Suitable for non-conductive material and big tank.</p>	 <p>Suitable for non-conductive material and middle-size tank.</p>
Model No.	EB1710 Wire Probe	EB1711 Hi-Temp Wire Probe	EB1720 Rod Probe
Probe material	SUS304	SUS304	SUS304/316
Weight material	CERAMIC	CERAMIC	————
Ambient temperature	-20~70°C	-20~70°C	-20~70°C
Operating temperature	-40~80°C	-40~190°C	-40~80°C
Tensile strength	2000Kgf	2000Kgf	————
Operation voltage	12~36Vdc	12~36Vdc	12~36Vdc
Output current	4 ~20mA(two wire)	4 ~20mA(two wire)	4 ~20mA(two wire)
Measuring range	0~5000pF	0~5000pF	0~5000pF
Accuracy	± 1%FS (25°C)	± 1%FS (25°C)	± 1%FS (25°C)
Protection	IP65	IP65	IP65
Connection	3"x5kg/cm² flange or 1-1/2"PT screw	3"x5kg/cm² flange or 1-1/2"PT screw	1-1/2"x5kg/cm² flange or 1-1/2"PT screw
Weight	Approx. 3.7kg(1M)	Approx. 4.2kg(1M)	Approx. 2.3kg(1M)
Operating pressure	40kg/cm²	40kg/cm²	40kg/cm²

EXPLOSION PROOF TYPE

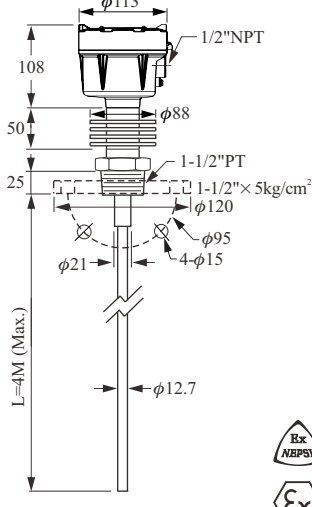
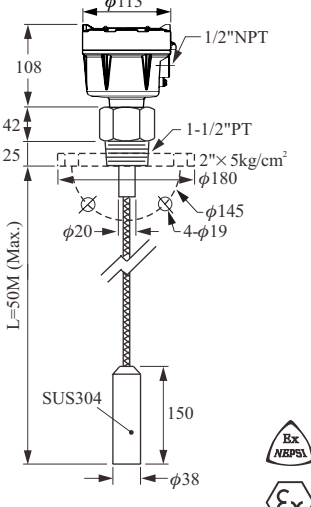
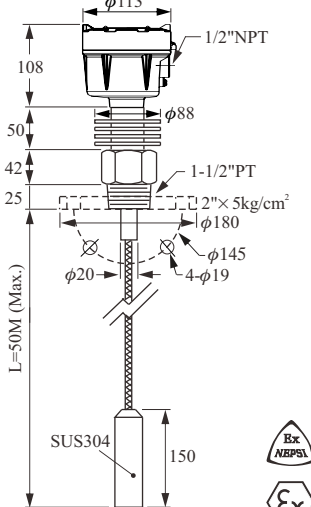
Dimensions (unit:mm)	 <p>Suitable for non-conductive material and middle-size tank.</p>	 <p>Suitable for non-conductive material and big tank.</p>	 <p>Suitable for non-conductive material and big tank.</p>
Model No.	EB1721 Hi-Temp Rod Probe	EB1730 Wire Probe	EB1731 Hi-Temp Wire Probe
Probe material	SUS304/316	SUS304	SUS304
Weight material	————	SUS304	SUS304
Ambient temperature	-20~70°C	-20~70°C	-20~70°C
Operating temperature	-40~190°C	-40~80°C	-40~190°C
Tensile strength	————	2000Kgf	2000Kgf
Operation voltage	12~36Vdc	12~36Vdc	12~36Vdc
Output current	4 ~20mA(two wire)	4 ~20mA(two wire)	4 ~20mA(two wire)
Measuring range	0~5000pF	0~5000pF	0~5000pF
Accuracy	± 1%FS (25°C)	± 1%FS (25°C)	± 1%FS (25°C)
Protection	IP65	IP65	IP65
Connection	1-1/2"x5kg/cm ² flange or 1-1/2"PT screw	2"x5kg/cm ² flange or 1-1/2"PT screw	2"x5kg/cm ² flange or 1-1/2"PT screw
Weight	Approx. 2.8kg(1M)	Approx. 2.3kg(1M)	Approx. 2.8kg(1M)
Operating pressure	40kg/cm ²	40kg/cm ²	40kg/cm ²

EXPLOSION PROOF TYPE

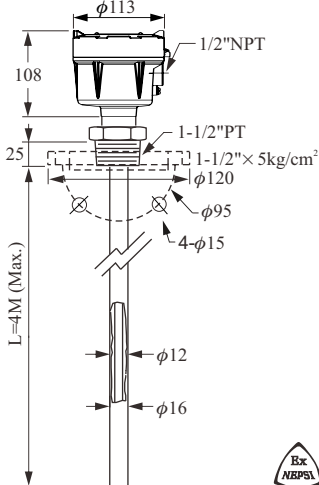
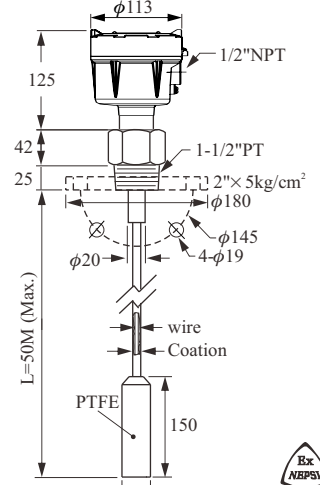
<p>Dimensions (unit:mm)</p>	 <p>EB1740 --- PVDF Coating EB1742 --- PP Coating EB1743 --- FEP Coating Suitable for conductive/ corrosive material and middle-size tank.</p>	 <p>EB1752 --- PP Coating EB1753 --- FEP Coating Suitable for conductive/ corrosive material and big tank.(weight can not be fixed at the bottom of tank)</p>
<p>Model No.</p>	<p>EB1740/42/43 Anti-Corrosion</p>	<p>EB1752/53 Anti-Corrosion Wire Probe</p>
<p>Probe material</p>	<p>SUS304+Coating</p>	<p>SUS304+Coating</p>
<p>Weight material</p>	<p>—————</p>	<p>SUS304+PTFE</p>
<p>Ambient temperature</p>	<p>-20~70°C</p>	<p>-20~70°C</p>
<p>Operating temperature</p>	<p>-40~80°C</p>	<p>-40~80°C</p>
<p>Tensile strength</p>	<p>—————</p>	<p>2000Kgf</p>
<p>Operation voltage</p>	<p>12~36Vdc</p>	<p>12~36Vdc</p>
<p>Output current</p>	<p>4 ~20mA(two wire)</p>	<p>4 ~20mA(two wire)</p>
<p>Measuring range</p>	<p>0~5000pF</p>	<p>0~5000pF</p>
<p>Accuracy</p>	<p>± 1%FS (25°C)</p>	<p>± 1%FS (25°C)</p>
<p>Protection</p>	<p>IP65</p>	<p>IP65</p>
<p>Connection</p>	<p>1-1/2"x5kg/cm² flange or 1-1/2"PT screw</p>	<p>2"x5kg/cm² flange or 1-1/2"PT screw</p>
<p>Weight</p>	<p>Approx. 2.3kg(1M)</p>	<p>Approx. 2.3kg(1M)</p>
<p>Operating pressure</p>	<p>40kg/cm²</p>	<p>40kg/cm²</p>

ORDER INFORMATION

Model Number	Order Code
EB5200	EBX10000-A1
EB52A0	EBX10000-B1
EB52A1	EBX10200-B1
EB5201	EBX10200-A1
EB5300	EBX10000-A2
EB53A0	EBX10000-B2
EB53A1	EBX10200-B2
EB5301	EBX10200-A2
EB5400	EBX10000-A3
EB54A0	EBX10000-B3
EB5500	EBX10000-A4
EB55A0	EBX10000-B4
EB5501	EBX10200-A4

Model Number	Order Code
EB1710	EBX1001C-A8
EB1711	EBX1021C-A8
EB1720	EBX1001C-A1
EB1721	EBX1021C-A1
EB1730	EBX1001C-A2
EB1731	EBX1021C-A2
EB1740	EBX1001C-B1□□□□□24
EB1742	EBX1001C-B1□□□□□18
EB1743	EBX1001C-B1□□□□□14
EB1752	EBX1001C-B2□□□□□18
EB1753	EBX1001C-B2□□□□□03

ACCESSORIES

Cable Conduit - Ex d IIC

Material: Washer — NBR

Body— Copper alloy(3/4"NPT)

Nickel plated(1/2"NPT)

HP415-A23100MH01(29-1104)

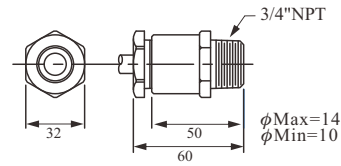

HP415-A23000MG01(29-1108)

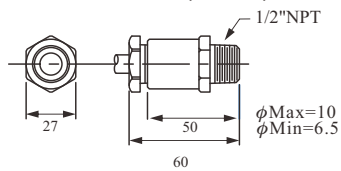

ORDER INFORMATION

EBX1 ⁰⁵ ⁰⁶ ⁰⁷ ⁰⁸ - ⁰⁹ ¹⁰ ¹¹ ¹² ¹³ ¹⁴ ¹⁵ ¹⁶ ¹⁷ ¹⁸ ¹⁹ ²⁰ ²¹ ²² ²³

⁰⁵ ⁰⁶ **Type**

- 00: Standard Type
- 02: Hi-Temp. Type
- 03: Sanitary Type
- 32: Sanitary+Hi-Temp. Type

⁰⁷ ⁰⁸ **Certificate**

- 00: None
- 1C: ATEX-Sealed Explosion-proof
- 1D: ATEX-Dust Explosion-proof
- 7C: NEPSI-Sealed Explosion-proof
- 7D: NEPSI-Dust Explosion-proof

⁰⁹ ¹⁰ **Probe Type**

- A1: Rod Probe Type
- A2: Cable Type
- A3: Two Rod Probe Type
- A4: Anti-wave tube Type
- A5: Anti-wave tube Coating Type
- A8: Insulator Type
- B1: Rod Coating Type
- B2: Cable Coating Type
- B3: Two Coating Rod Probe
- B4: Anti-wave tube Two Coating Type

Connection

¹¹ ¹²

- Flange item
- AK: JIS-FF
- AN: ANSI-RF
- AS: DIN-FF

Thread item

- AA: JIS
- AB: ISO
- AC: ANSI
- AD: DIN

¹³ ¹⁴

- A8: 1"
- B1: 1-1/2"
- B2: 2"
- B4: 2-1/2"
- B5: 3"

D8: DN25

- E1: DN40
- E2: DN50
- E3: DN65
- E4: DN80

¹⁵ ¹⁶

- 01: PT male
- 03: PF male
- 05: BSP male
- 07: NPT male
- 13: GAS male
- 40: 5 kg/cm²
- 42: 10 kg/cm²
- 48: 150 Lbs
- 49: 300 Lbs
- 57: PN10
- 58: PN16

(Next page)



⑤⑥⑦⑧⑨⑩⑪⑫⑬⑭⑮⑯⑰⑱⑲⑳㉑㉒㉓
EBX1 -

⑰⑱ Probe Material

- MA: SUS 304
- MB: SUS 316
- 03: FEP
- 14: PFA
- 18: PP
- 24: PVDF

⑲ Communication

- A: None
- B: HART

⑳㉑㉒㉓ Length

Code	Probe Range
0500~4000	500mm~4000mm, Rod Probe Type
0500~1500	500mm~1500mm, Two Rod Probe Type
0500~A500	500mm~50000mm, Cable Type ("A" means multiplied by 100 times)

- * Tolerance of the total product length is $\pm 5\text{mm}$
- * Characteristics, specifications and dimensions are subject to change without notice.
- * Please contact your nearest distributing office for further informations.

INSTALLATION

1. Please choose Two Rod Probe type for non conductive tank (Fig.1), or install a concentric circles metal pipe shield with vent hole at the top outside the probe (Fig. 2)
2. The rod or wire probe should be parallel to the tank wall. To prevent material from sticking between the probe and tank wall, the probe shouldn't be too close to the tank wall.
3. If the container is irregular-shaped, such as a cylindrical, and the medium is liquid with low viscosity, the rod should be placed inside a concentric circles metal pipe shield with vent hole at the top.(Fig. 2)
4. Coating Probe type is necessary for conductive media (eg. Water...) , as the bare electrode can't operation normally in conductive media.
5. During the installation, the process connection should be grounded. An installation without proper grounding will not guarantee normal operation of the device later on.
6. For non-conductive medium of powder or granules in big tank, the wire probe should be fixed to the bottom of tank
7. When all electrical connections inside of Admittance Level Transmitter housing are finished, the housing cover and the conduit opening should be sealed and tightened to prevent moisture from soaking in.
8. If an agitator is in place (see fig. 4), a pipe shield outside the probe is recommended.

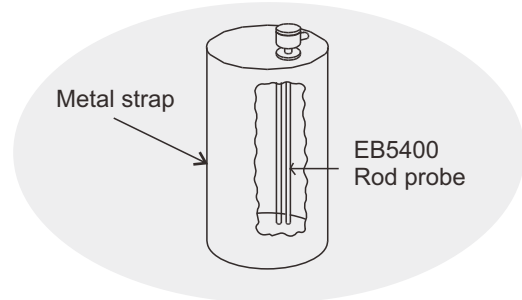

Fig. 1

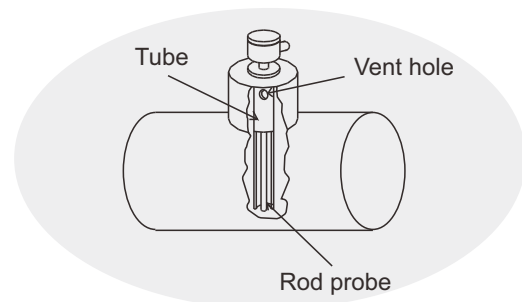

Fig. 2

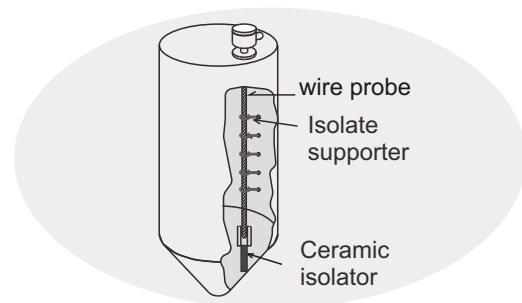

Fig. 3

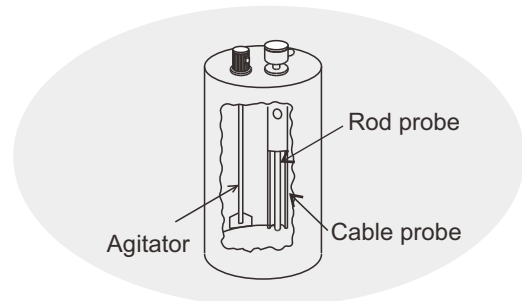

Fig. 4