



## Cable Float Level Switch



# PRODUCT INTRODUCTION

## DESCRIPTION

The Float Level Switch is made from chemical resistant polypropylene. It is durable, low-cost, and specially designed to assist with long range and multiple point level detection in liquids. It is also suitable for tanks containing pumps and granular solutions.

## APPLICATION

FAC: Suitable for pump controlled systems

FAR/ P / D/ E: Suitable for pump controlled waste water with a low Specific Gravity (SG level).

FAS: High temperature solutions

FAL/ J: Cleaner water, and installation with smaller process connections.

It is suggested to apply Reed Switch contact models in PLC or DCS control.

## WORKING PRINCIPLE

The Cable Float Level Switch is structured by using either micro switches proximity switches or reed switches to control the contact. Its user-friendly design is ideal for level measurement. The switches will transmit an ON or OFF contact signal output when the float rises and turns upwards. The switch contains a metal ball that can slide as the float position changes.

For different water or solution temperatures, different float materials are available for selection. Plastic and stainless steel switches are the most common.

The cable float level switch can not only be used in clear liquids but also can be used in granular liquids. Long distance detection points and multi-point contacts are also available.

Cable float level switches can be applied in all water management, petrochemical, chemical industries. Other uses include: air-conditioner systems, drainage systems, most tanks or containers with level switch requirements.

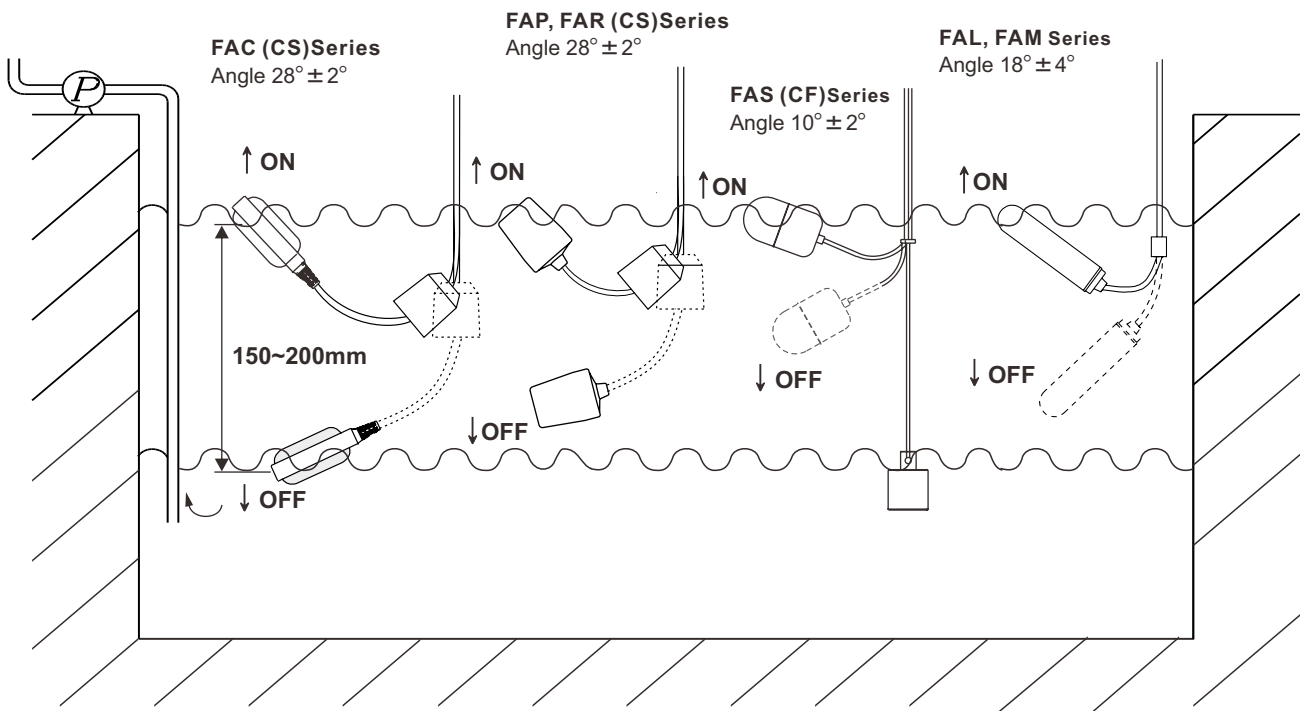

# SPECIFICATIONS

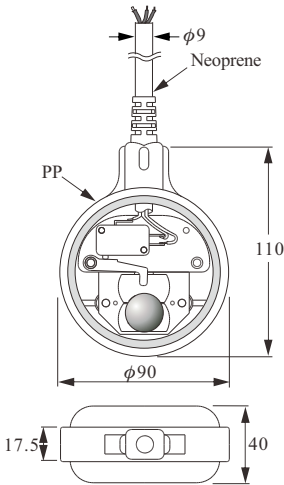
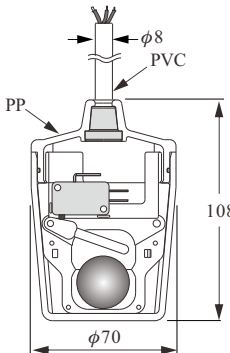
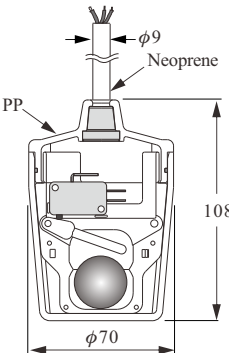
Dimensions (Unit:mm)			
	<b>Model</b>	<b>FAC A/B/C Round type</b>	<b>FAP A/B/C Cup type</b>
<b>Switch</b>	Micro switch	Micro switch	Micro switch
<b>Float material</b>	P.P.		
<b>Cable spec</b>	Neoprene Cable 1mm <sup>2</sup> x3C or 2C	PVC Cable 1.25mm <sup>2</sup> x3C or 2C	Neoprene Cable 1mm <sup>2</sup> x3C or 2C
<b>Contact rating</b>	10A/ 250Vac (std.) or 15A/ 250Vac		
<b>Contact form</b>	N.O or N.C or SPDT		
<b>Operating temp.</b>	-10°C~80°C	0°C~60°C	-10°C~80°C
<b>Specific gravity</b>	0.6	0.6	0.6
<b>Weight approx.</b>	770g/5M	290g/1M	290g/1M
<b>Pressure</b>	2 kg/cm <sup>2</sup>	2 kg/cm <sup>2</sup>	2 kg/cm <sup>2</sup>
<b>Wire voltage</b>	600 Vac	600 Vac	600 Vac
<b>Isolation resistance</b>	Min 100 MΩ		
<b>Contact resistance</b>	Max. 100mΩ + (70mΩ/m)		
<b>Actuation angle</b>	28° ± 2°	28° ± 2°	28° ± 2°
<b>Protection</b>	IP68	IP68	IP68

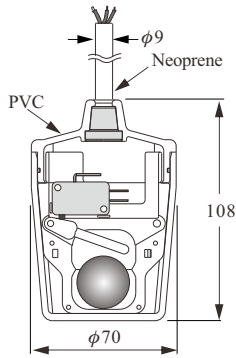
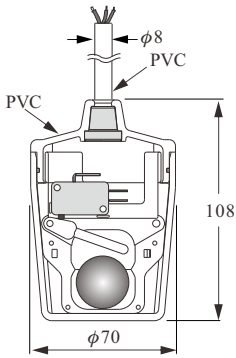
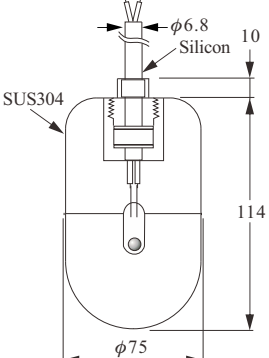
<b>Dimensions (Unit:mm)</b>			
	<b>Model</b>	<b>FAD A/B/C Cup type</b>	<b>FAE A/B/C Cup type</b>
<b>Switch</b>	Micro switch	Micro switch	Mercury switch
<b>Float material</b>	PVC		SUS304
<b>Cable spec</b>	Neoprene Cable 1mm <sup>2</sup> x3C or 2C	PVC Cable 1.25mm <sup>2</sup> x3C or 2C	Silicon Cable 0.75mm <sup>2</sup> x3C or 2C
<b>Contact rating</b>	10A/ 250Vac (std.) or 15A/ 250Vac		1A/ 230Vac
<b>Contact form</b>	N.O or N.C or SPDT		N.O or N.C or SPDT
<b>Operating temp.</b>	0°C~60°C	0°C~60°C	0°C~170°C
<b>Specific gravity</b>	0.6	0.6	0.5
<b>Weight approx.</b>	290g/1M	290g/1M	480g/5M
<b>Pressure</b>	2 kg/cm <sup>2</sup>	2 kg/cm <sup>2</sup>	2 kg/cm <sup>2</sup>
<b>Wire voltage</b>	600 Vac	600 Vac	300 Vac
<b>Isolation resistance</b>	Min 100 MΩ		—
<b>Contact resistance</b>	Max. 100mΩ+(70mΩ/m)		Max. 1Ω+( 70mΩ/m)
<b>Actuation angle</b>	28° ± 2°	28° ± 2°	10° ± 2°
<b>Protection</b>	IP68	IP68	IP68

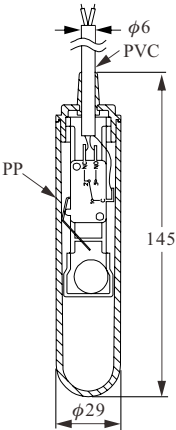
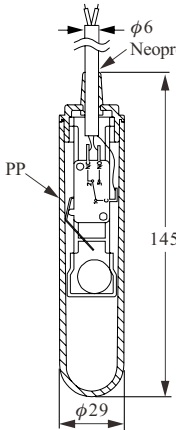
<b>Dimensions (Unit:mm)</b>		
	<b>Model</b>	<b>FAL A/B/C Bar type</b>
<b>Switch</b>	Micro switch	
<b>Float material</b>	P.P.	
<b>Cable spec</b>	PVC Cable 0.75mm <sup>2</sup> x3C	Neoprene Cable 0.75mm <sup>2</sup> x3C
<b>Contact rating</b>	3A/ 125/250Vac	
<b>Contact mode</b>	N.O or N.C or SPDT	
<b>Operating temp.</b>	-0°C~60°C	-10°C~80°C
<b>Specific gravity</b>	0.8	
<b>Weight approx.</b>	113 ± 2g/1M Cable	
<b>Pressure</b>	4.5 kg/cm <sup>2</sup>	
<b>Wire voltage</b>	600 Vac	
<b>Isolation resistance</b>	Min 100 MΩ	
<b>Contact resistance</b>	Max. 100mΩ + (70mΩ/m)	
<b>Actuation angle</b>	Up 18° ± 4° / Down 3° ± 3°	
<b>Protection</b>	IP68	

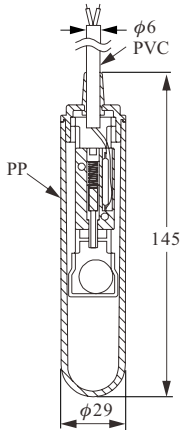
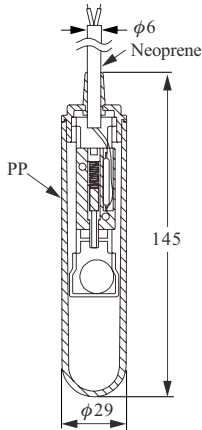
<b>Dimensions (Unit:mm)</b>		
	<b>Model</b>	<b>FAJ A/B/C Bar type</b>
<b>Switch</b>	Reed Switch	
<b>Float material</b>	P.P.	
<b>Cable spec</b>	PVC Cable 0.75mm <sup>2</sup> x3C	Neoprene Cable 0.75mm <sup>2</sup> x3C
<b>Contact rating</b>	AC70 VA / DC50 W(N.O), 20W(N.C, SPDT)	
<b>Contact mode</b>	N.O or N.C or SPDT	
<b>Operating temp.</b>	-0°C~60°C	-10°C~80°C
<b>Specific gravity</b>	0.8	
<b>Weight approx.</b>	115±2g/1M Cable	
<b>Pressure</b>	4.5 kg/cm <sup>2</sup>	
<b>Wire voltage</b>	300 Vac/ 350Vdc(N.O), 150 Vac/ 200Vdc(N.C, SPDT)	
<b>Isolation resistance</b>	Min 100MΩ	
<b>Contact resistance</b>	(N.O) Max.100mΩ+(70mΩ/m),(N.C,SPDT) Max.150mΩ+(70mΩ/m)	
<b>Actuation angle</b>	Up 18°±4°/ Down 3°±3°	
<b>Protection</b>	IP68	

## WEIGHTS DIMENSIONS

FAPW-03  
FAPW-05

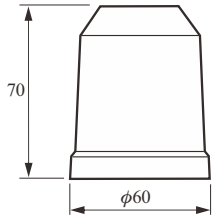

FASW

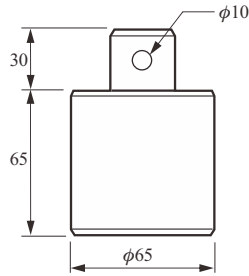

FAB-0010

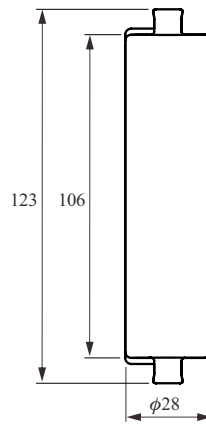

Model	Material	Weight
FAPW-03 FAPW-05	PP	0.3kg 0.5kg
FASW	SUS304	1.8kg
FAB-0010	PP	0.15kg

## CONTACT MODE

### 1. SPST (N.O)

FACA

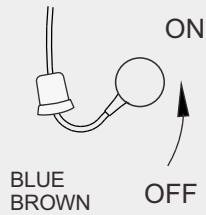

FAPA/FAEA

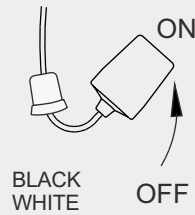

FARA/FADA

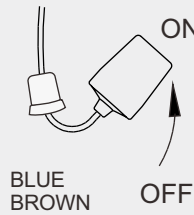

FASA

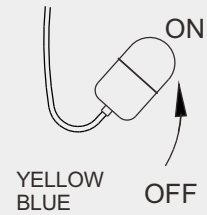

### 2. SPST (N.C)

FACB

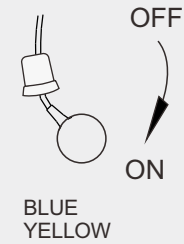

FAPB/FAEB

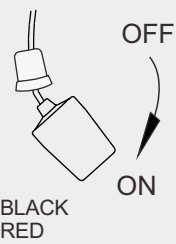

FARB/FADB

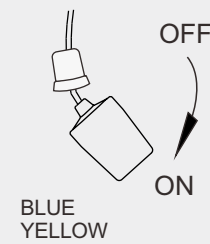

FASB

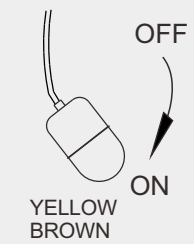

### 3. SPDT (1C)

FACC

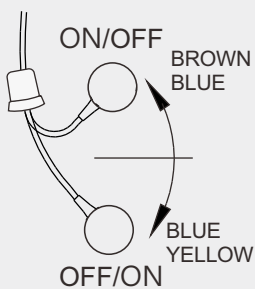

FAPC/FAEC

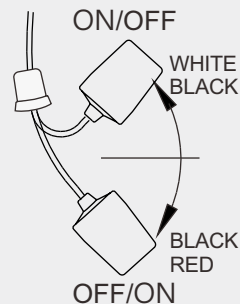

FARC/FADC

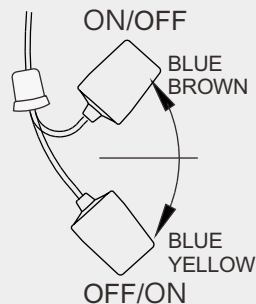

FASC

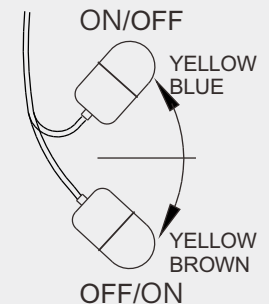

# WIRING

## Micro Switch

When the float hasn't contacted the liquid, the blue and black wires are in an open state and the contact mode will be NC. When the liquid level rises and lifts the float until it reaches the actuation angle, the brown and black wires will be in an open state and the contact mode will be NO.

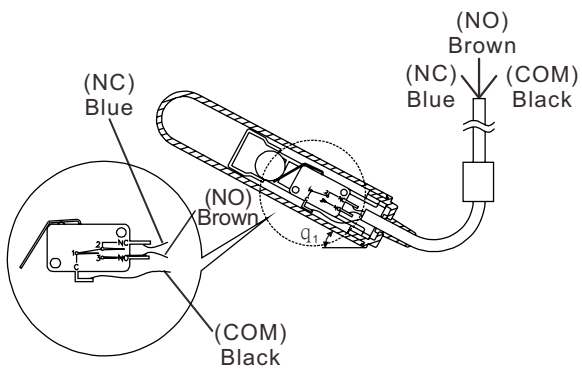
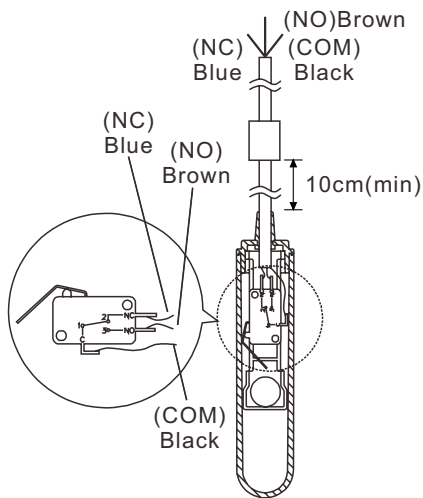

## Reed Switch

When the liquid level is low, the metal ball remains away from the sensing range and the brown and black wires are in an open state (NC mode). When the liquid level rises and lifts the float until it reaches the actuation angle, the brown and black wires will be in an open state (NO mode).

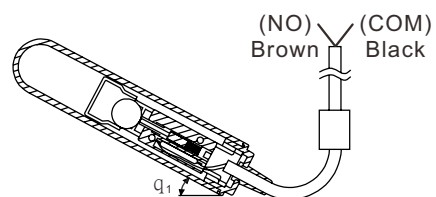
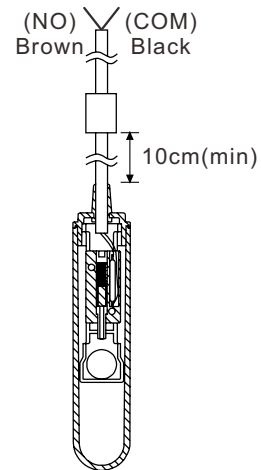



# INSTALLATION GUIDE

## DIMENSIONS

The float's action length (a) must be shorter than the distance between the wall and the cable (A) ; if not, it will not function accurately.

The lowest float level (d) must be higher than the lowest water level of the pump (D).

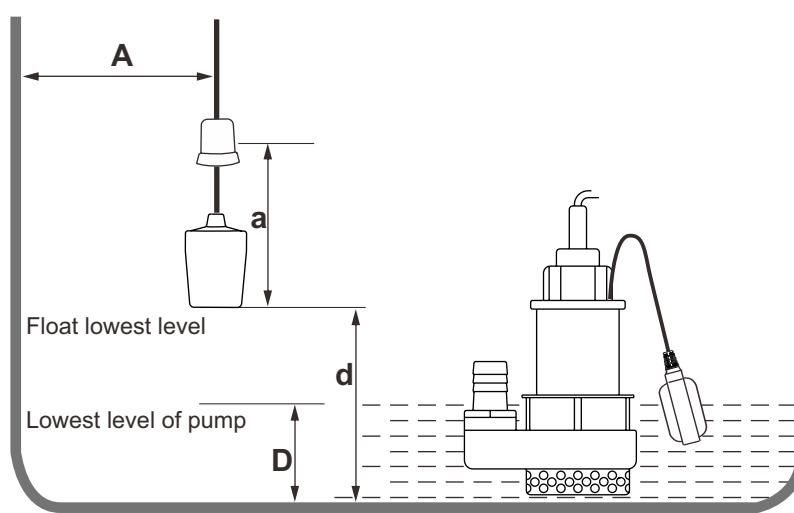

## PRECAUTIONS

Keep a proper distance between the installation position and the water pump inlet to prevent the float switch from being sucked in towards the pump.

There should be a proper distance between the installation position and water inlet to prevent any direct water impact. If it can't be avoided, please install a pipe-shield or plate that lowers the turbulence.

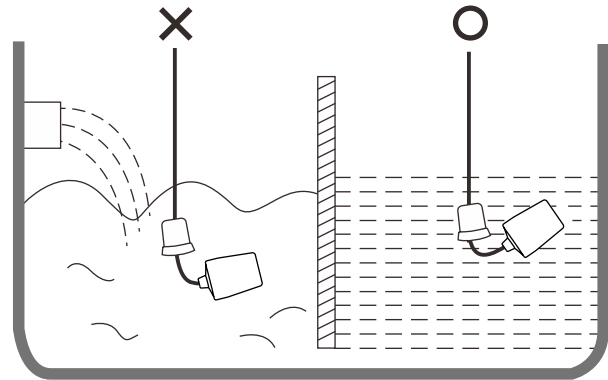
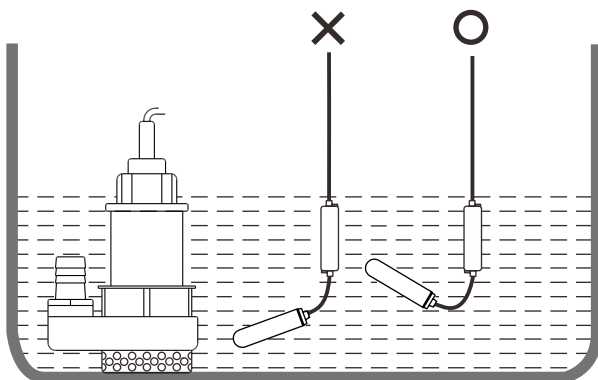

# APPLICATION

The FBX type is suitable for installation from the tank's roof/top for level control and monitoring.

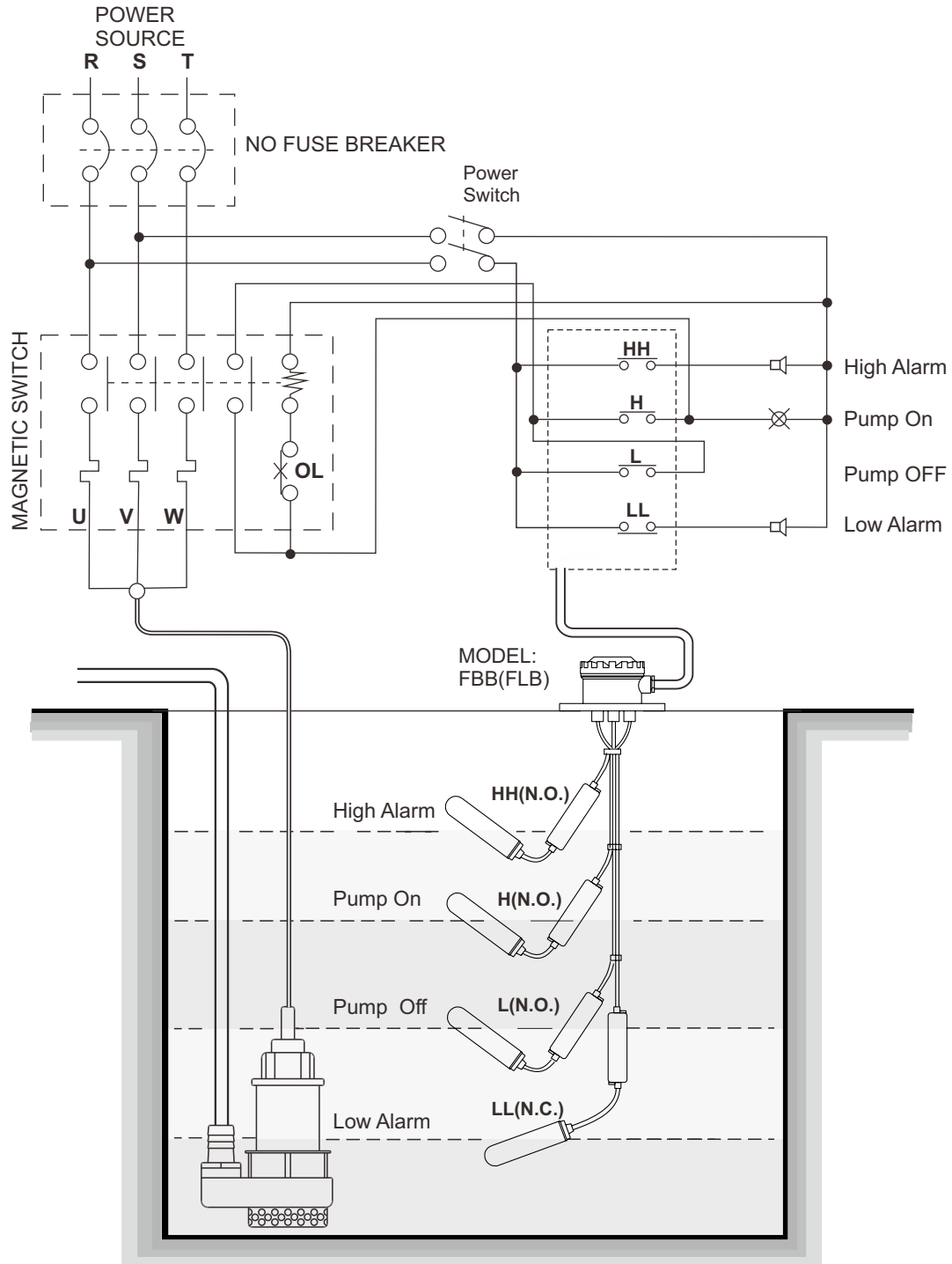

# MODEL NUMBER / ORDER CODE COMPARISON TABLE

Model Number	Order Code
FAC	FAX10100-AD□P1
FACA	FAX10100-ADAP1
FACB	FAX10100-ADBP1
FACC	FAX10100-ADCP1

FAP	FAX10100-BD□P2
FAPA	FAX10100-BDAP2
FAPB	FAX10100-BDBP2
FAPC	FAX10100-BDCP2
FAR	FAX10100-BD□P1
FARA	FAX10100-BDAP1
FARB	FAX10100-BDBP1
FARC	FAX10100-BDCP1
FAD	FAX10100-BD□C1
FADA	FAX10100-BDAC1
FADB	FAX10100-BDBC1
FADC	FAX10100-BDCC1
FAE	FAX10100-BD□C2
FAEA	FAX10100-BDAC2
FAEB	FAX10100-BDBC2
FAEC	FAX10100-BDCC2

FAS	FAX10100-DA□M3
FASA	FAX10100-DAAM3
FASB	FAX10100-DABM3
FASC	FAX10100-DACM3

FAL	FAX10100-CB□P2
FAM	FAX10100-CB□P1
FAJ	FAX10100-CF□P2
FAK	FAX10100-CF□P1

FAPW-03	FAX□M1P-1806007002
FAPW-05	FAX□M1P-1806007003
FASW	FAX□M1P-MA06509501
FAB-0010	FAX□M1P-1802810601

# ORDER INFORMATION

FAX 1 0 1 0 0 - <sup>09</sup> <sup>10</sup> <sup>11</sup> <sup>12</sup> <sup>13</sup> <sup>14</sup> <sup>15</sup> <sup>16</sup> <sup>17</sup>

**⑨⑩ Float type and switch**

- AD:  $\phi$ 90\*110 Micro switch(10A)
- AE:  $\phi$ 90\*110 Micro switch(15A)
- BD:  $\phi$ 70\*108 Micro switch(10A)
- BE:  $\phi$ 70\*108 Micro switch(15A)
- CB:  $\phi$ 29\*145 Micro switch(3A)
- CC:  $\phi$ 29\*145 Micro switch(3A)+Ground
- CF:  $\phi$ 29\*145 Reed Switch
- CG:  $\phi$ 29\*145 Reed Switch+Ground
- DA:  $\phi$ 75\*120 Mercury switch

※ It is suggested to apply Reed Switch contact models in PLC or DCS control.

**⑪ Contact mote**

- A: N.O.
- B: N.C.
- C: SPDT

**⑫⑬ Float and cable material**

- P1: Float PP Neoprene cable
- P2: Float PP PVC cable
- C1: Float PVC Neoprene cable
- C2: Float PVC PVC cable
- M3: Float SUS304 Silicon cable

**⑭⑮⑯⑰ Length**

Code	Length
0600	600mm (Min imum order length)
3000	3000mm
5000	5000mm
A100	10000mm ("A" Multiply 100 times)
A150	15000mm ("A" Multiply 100 times)
A450	45000mm (Maximam order length)

# HOW TO ORDER CABLE FLOATS (FB TYPE)

Various types of multi-point products can be selected to meet the user's needs.

For example:

FBX10000-□□□□□C type is suitable for corrosive solutions.

FBX10000-□□□□□B type is suitable for high-temperature waste water

## DISTANCE OF CONTROL POINTS

	NO	NC
ℓ 1 : _____ mm	<input type="checkbox"/>	<input type="checkbox"/>
ℓ 2 : _____ mm	<input type="checkbox"/>	<input type="checkbox"/>
ℓ 3 : _____ mm	<input type="checkbox"/>	<input type="checkbox"/>
ℓ 4 : _____ mm	<input type="checkbox"/>	<input type="checkbox"/>
L : _____ mm		

